

Specification of: TEM 01-0250-23-14-J

High performance centrifugal fan Nicotra Gebhardt silentvent with external PREMIUM EFFICIENCY motor in efficiency class IE3 (IEC 60034-30)

Single inlet with direct drive. Lap-jointed scroll housing made from galvanized steel sheet, without pedestal for vertical or horizontal mounting. Galvanized impeller with forward curved blades Motor B5, mounted outside the airstream. Impeller and shaft statically and dynamically balanced in accordance with DIN ISO 21940-11, completely maintenance free. The motor is equipped with PTC Thermistors as a standard. Three phase 400 V, 50 Hz, single speed.

Technical data of the fan: TEM 01-0250-23-14-J

[fulfills the ErP requirements 2015](#)

Description	Value Dimension
Specified duty point	
Actual duty point	
Installation acc. DIN 24163 Part 1	A
Reference density (Rho1)	1.20 kg/m ³
Medium temperature (t)	20 C
Fan weight	37 kg
Rated data	
Phases-Voltage-Frequency	3~230/400-50 V-Hz
Frame size-poles:	90L / IE3-2
Motor rating (P _N)	2.2 kW
Rated motor speed (n _N)	2845 min ⁻¹
Rated motor current (I _N)	7,7/4,4 A
operational limits	
Temperature range of conveying medium (t _{min} ... t _{max})	-20...60 C
ErP-Data at best efficiency and density - kg/m³	
measurement- / efficiency category	B / total
design status of VSD	without VSD
overall efficiency (ETA _{opt})	47.8 %
achieved efficiency grade (N _{ist})	51.7
required efficiency grade in 2013 / 2015 (N)	42 / 49
Air flow rate (V _{opt})	2180 m ³ /h
pressure rise (dp _{opt})	1920 Pa
Fan speed (n _{vopt})	2970 min ⁻¹
motor power input (P _{1opt})	2.43 kW
specific ratio (d _{dpopt})	1.019

Fan curve to TEM 01-0250-23-14-J

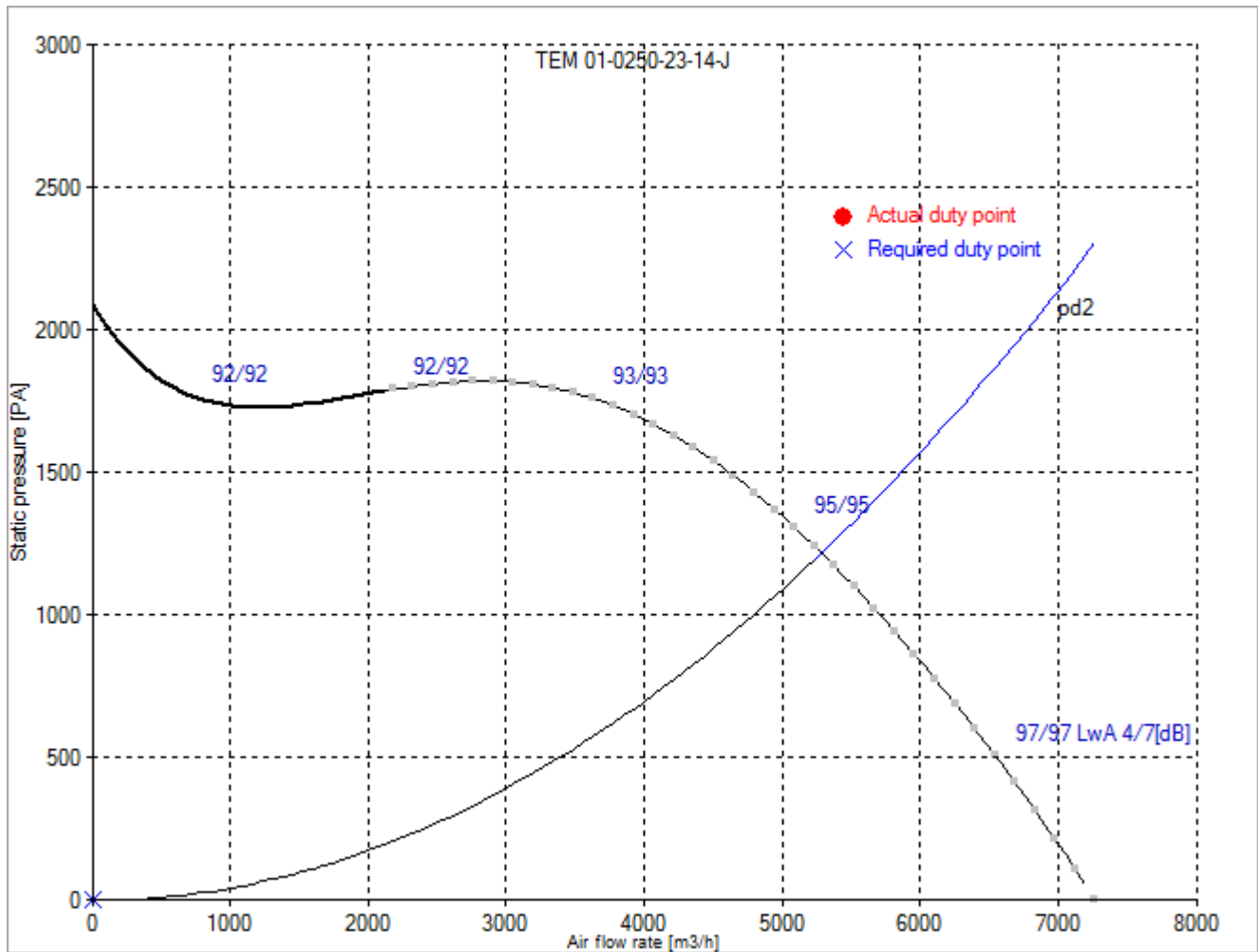

Dimensions to TEM 01-0250-23-14-J

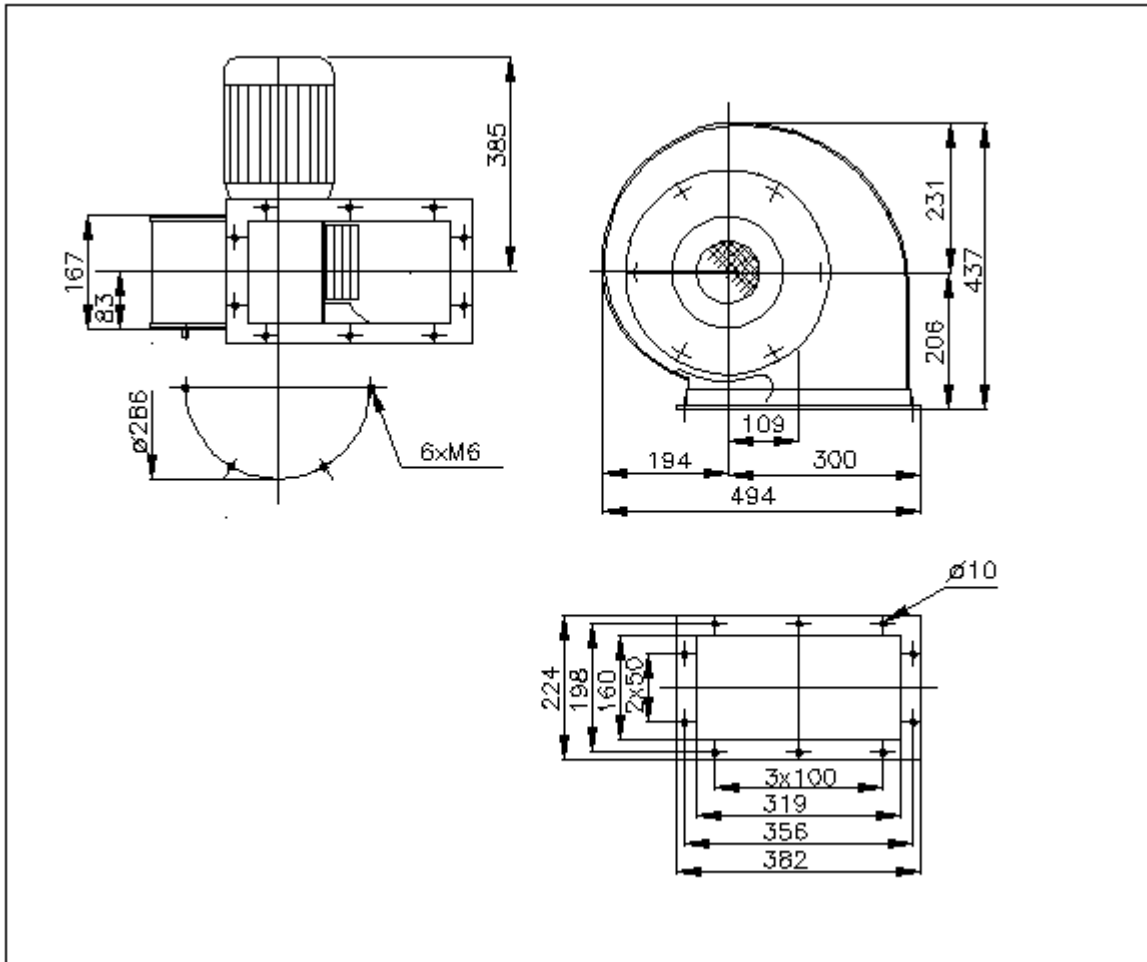

Rotation:
Handing:

RD
90